

Article number: 209925V25M8

Description: E+G Threaded end-caps - GN 992.5-V25-M8

Measures

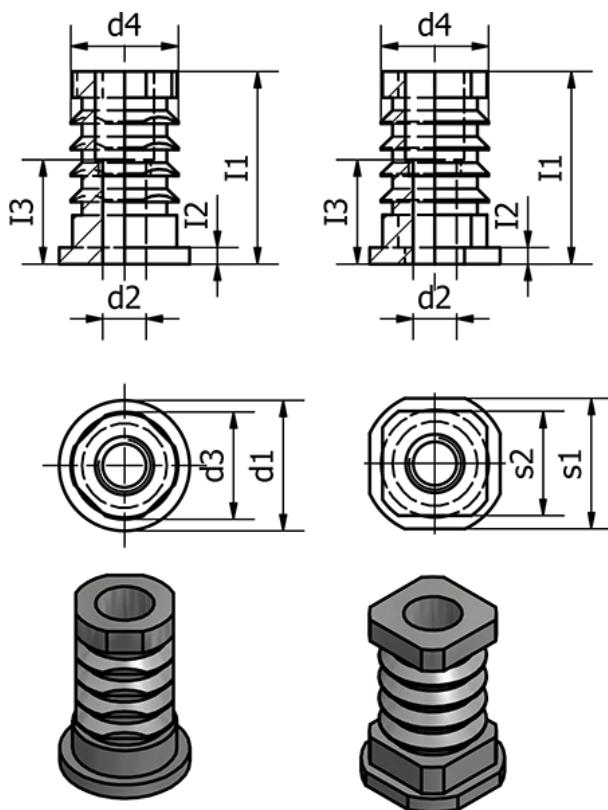

d1 =	s2	= 21
d2 = M8	Weight (g) =	61
d3 =		
d4 = 21.5		
I1 = 29.5		
I2 = 2.5		
I3 = 16		
s1 = 25		